



Aluminum electrolytic capacitors

Series/Type: B43888

The following products presented in this data sheet are being withdrawn.

Ordering Code	Substitute Product	Date of Withdrawal	Deadline Last Orders	Last Shipments
B43888G9335M008		2023-09-01	2023-09-15	2024-03-15
B43888G9335M004	-	2023-09-01	2023-12-15	2024-03-15
B43888G9335M002	-	2023-09-01	2023-12-15	2024-03-15



Ordering Code	Substitute Product	Date of Withdrawal	Deadline Last Orders	Last Shipments
B43888G9335M000	-	2023-09-01	2023-12-15	2024-03-15
B43888G5335M008	-	2023-09-01	2023-12-15	2024-03-15
B43888G5335M004	-	2023-09-01	2023-12-15	2024-03-15
B43888G5335M002	-	2023-09-01	2023-12-15	2024-03-15
B43888G5335M000	-	2023-09-01	2023-12-15	2024-03-15
B43888G5226M000		2018-06-22	2018-09-30	2018-12-31
B43888G4336M000		2018-06-22	2018-09-30	2018-12-31
B43888G4335M008	-	2023-09-01	2023-12-15	2024-03-15
B43888G4335M004	-	2023-09-01	2023-12-15	2024-03-15
B43888G4335M002	-	2023-09-01	2023-12-15	2024-03-15
B43888G4335M000		2023-09-01	2023-12-15	2024-03-15

Please contact your nearest TDK sales office if you need support in selecting a suitable substitute. The addresses of our worldwide sales network are presented at www.tdk-electronics.tdk.com/sales.

Long-life grade capacitors

Applications

- Power supply
- Signal processing

Features

- Low ESR
- Low inductance
- Low self-heating
- Low loss

Construction

- Electrodeless
- Leadless
- High capacitance
- High reliability
- Long useful life





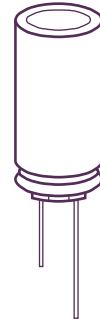







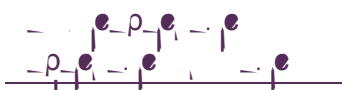











Delivery mode

- Tape
- Cartridge
- Bulk
- Single
- Tray
- Reel





Specifications and characteristics in brief





































	
	
	
	$I_{leak} = 0.03 \mu A \cdot \left(\frac{C_R}{\mu F} \cdot \frac{V_R}{V} \right) + 15 \mu A$
	
	
	
	
	
	
	
	
	



B43888

Long useful life – 105 °C

Technical data and ordering codes

Ordering code	Ordering code	Ordering code	Ordering code
			
			
			
			
			
			
			
			
			

Composition of ordering code



Useful

full life

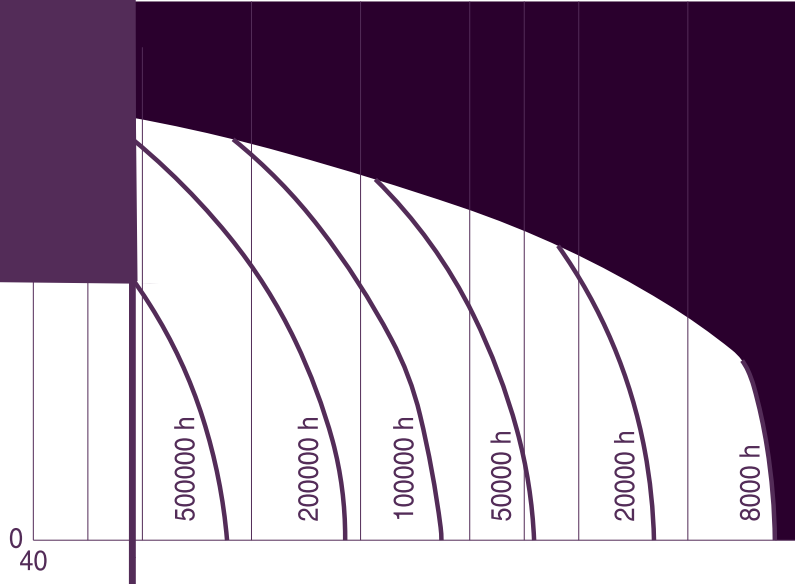

Frequency factor of permissible ripple current I_{AC} versus frequency f

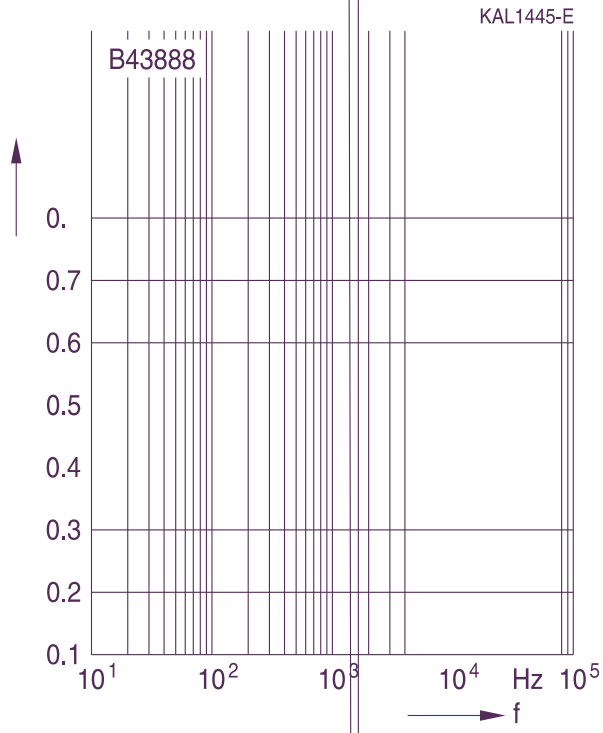

Taping

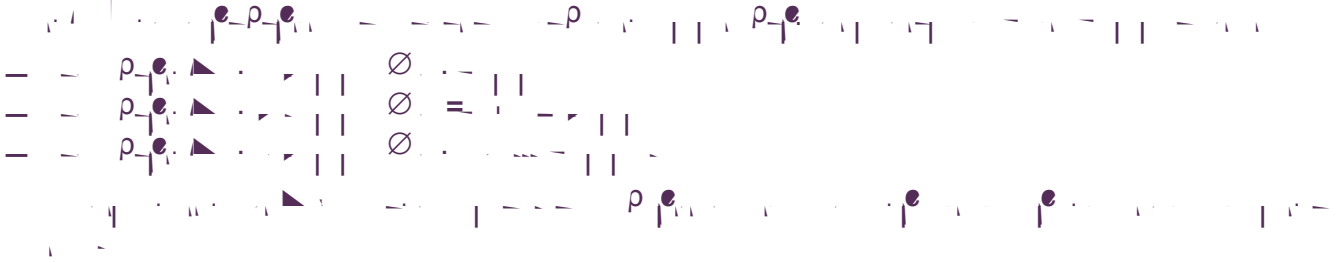

Lead spacing 3.5 mm (\varnothing d = 8 mm)



Adh



B43888

Long useful life – 105 °C

Lead spacing 5.0 mm (∅ d = 8 mm)

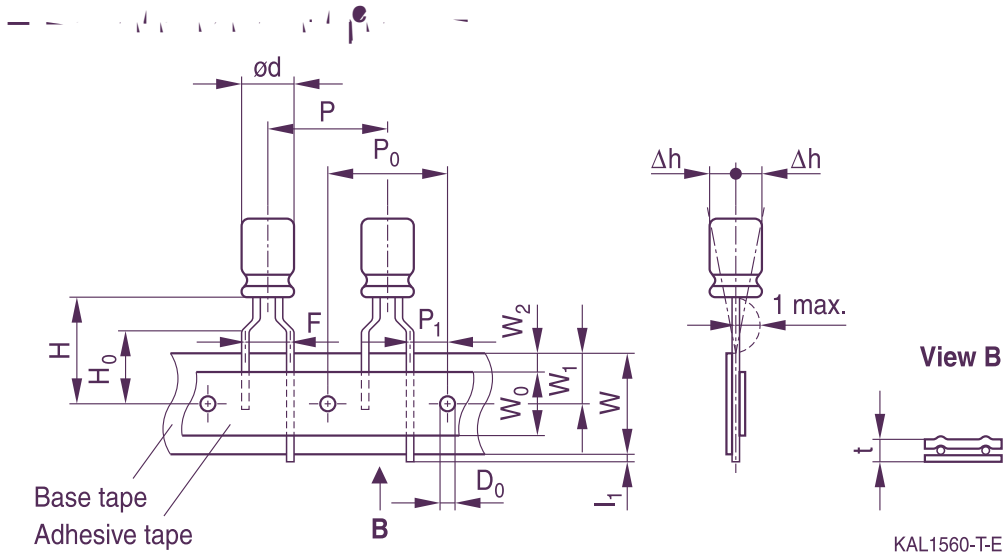

Lead spacing 5.0 mm (∅ d = 10 ... 12.5 mm)

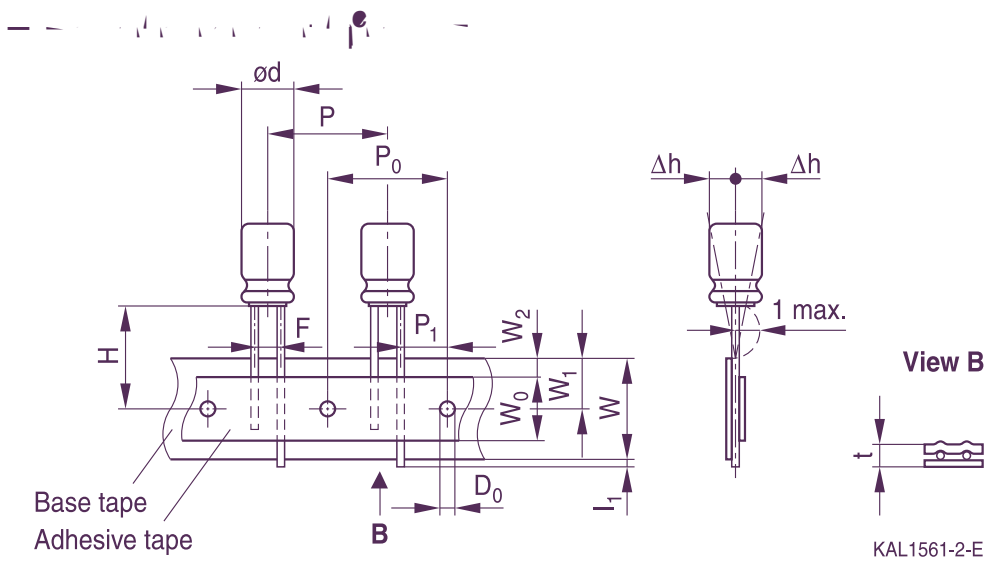

Dimensions in mm

∅	P	P ₀	P ₁	W ₂	W ₁	W	D ₀	H	Δh	Δ
8	5.0	10.0	8.0	0.2	0.1	0.1	10.0	1.0	0.1	0.1
10	5.0	10.0	8.0	0.2	0.1	0.1	10.0	1.0	0.1	0.1
12.5	5.0	10.0	8.0	0.2	0.1	0.1	10.0	1.0	0.1	0.1

ρ₁ ρ × ×



Lead spacing 7.5 mm ($\varnothing d = 16 \dots 18$ mm)

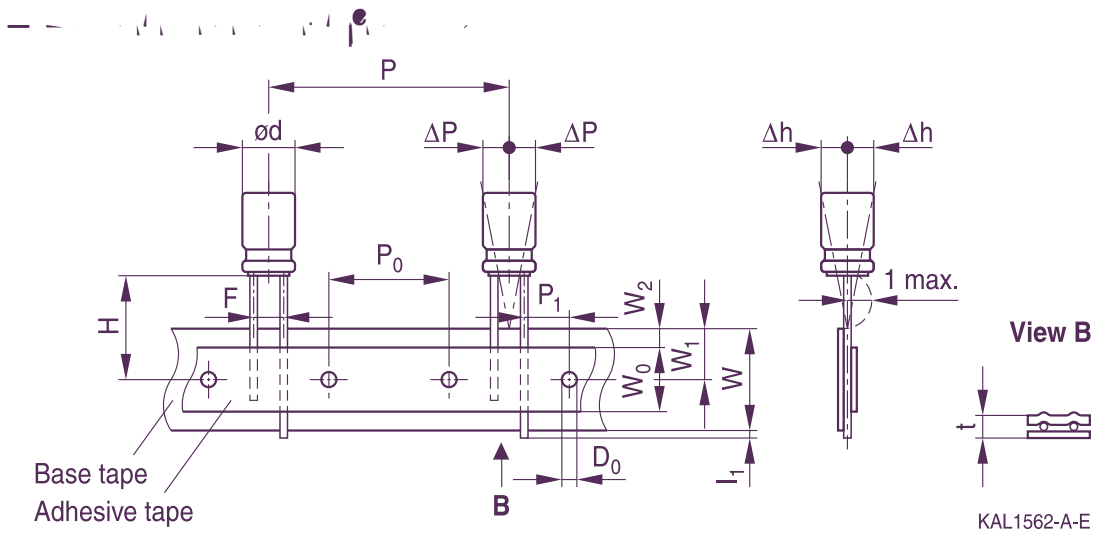

Dimensions in mm

\varnothing	P	P_0	P_1	F	W_0	W_1	W_2	D_0	l_1	H	Δh	Δ	Δ
16	7.5	10.0	10.0	0.5	1.0	1.0	1.0	1.0	1.0	1.0	0.5	0.5	0.5
18	7.5	10.0	10.0	0.5	1.0	1.0	1.0	1.0	1.0	1.0	0.5	0.5	0.5

ρ_1 ρ_2 ρ_3 ρ_4 ρ_5 ρ_6 ρ_7 ρ_8 ρ_9 ρ_{10} ρ_{11} ρ_{12} ρ_{13} ρ_{14} ρ_{15} ρ_{16} ρ_{17} ρ_{18} ρ_{19} ρ_{20} ρ_{21} ρ_{22} ρ_{23} ρ_{24} ρ_{25} ρ_{26} ρ_{27} ρ_{28} ρ_{29} ρ_{30} ρ_{31} ρ_{32} ρ_{33} ρ_{34} ρ_{35} ρ_{36} ρ_{37} ρ_{38} ρ_{39} ρ_{40} ρ_{41} ρ_{42} ρ_{43} ρ_{44} ρ_{45} ρ_{46} ρ_{47} ρ_{48} ρ_{49} ρ_{50} ρ_{51} ρ_{52} ρ_{53} ρ_{54} ρ_{55} ρ_{56} ρ_{57} ρ_{58} ρ_{59} ρ_{60} ρ_{61} ρ_{62} ρ_{63} ρ_{64} ρ_{65} ρ_{66} ρ_{67} ρ_{68} ρ_{69} ρ_{70} ρ_{71} ρ_{72} ρ_{73} ρ_{74} ρ_{75} ρ_{76} ρ_{77} ρ_{78} ρ_{79} ρ_{80} ρ_{81} ρ_{82} ρ_{83} ρ_{84} ρ_{85} ρ_{86} ρ_{87} ρ_{88} ρ_{89} ρ_{90} ρ_{91} ρ_{92} ρ_{93} ρ_{94} ρ_{95} ρ_{96} ρ_{97} ρ_{98} ρ_{99} ρ_{100}

Cut or kinked leads



Cut leads



With stand-off rubber seal

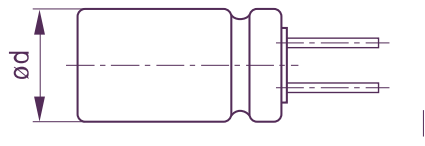

KAL1

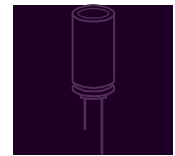

Kinked leads



With stand-off rubber seal

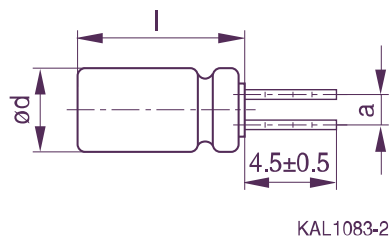
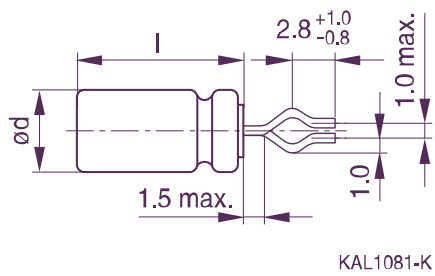

With flat rubber seal

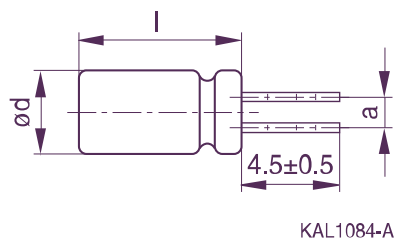
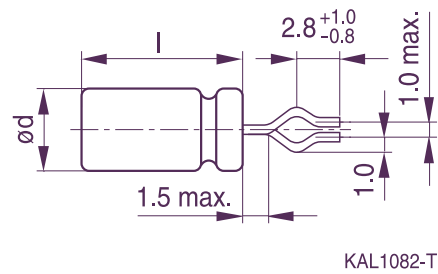

Symbol	Symbol
X	±
X	±
X	±
X	±
X	±
X	±
X	±
X	±
X	±
X	±
X	±
X	±
X	±
X	±

PAPR leads



Crimped leads



With stand-off rubber seal

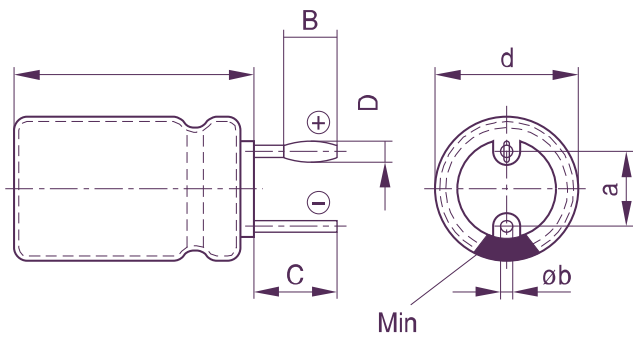

KAL1087-Z-E

J leads

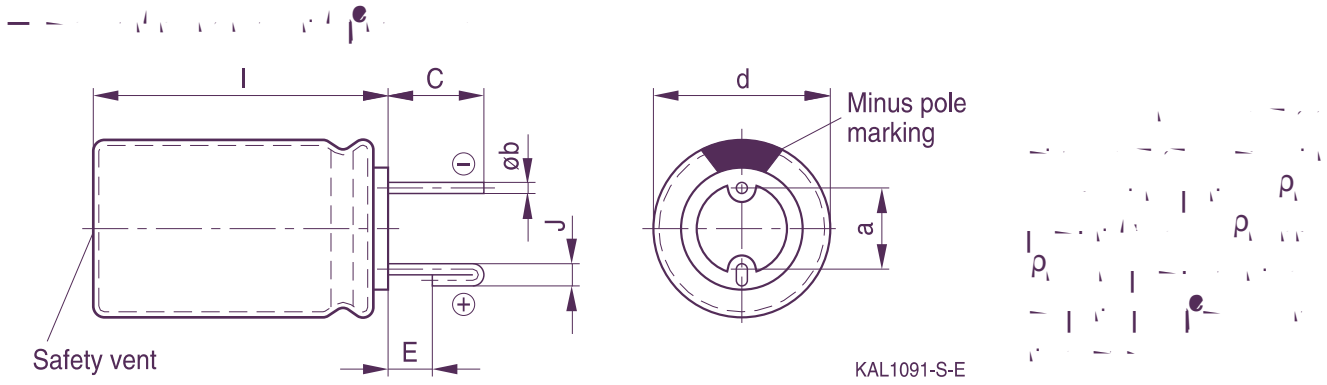

Suggestion for PCB hole diameter

Suggestion for PCB hole di

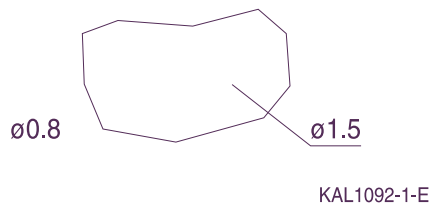



B43888

Long useful life – 105 °C

Bent 90° leads for horizontal mounting pinning

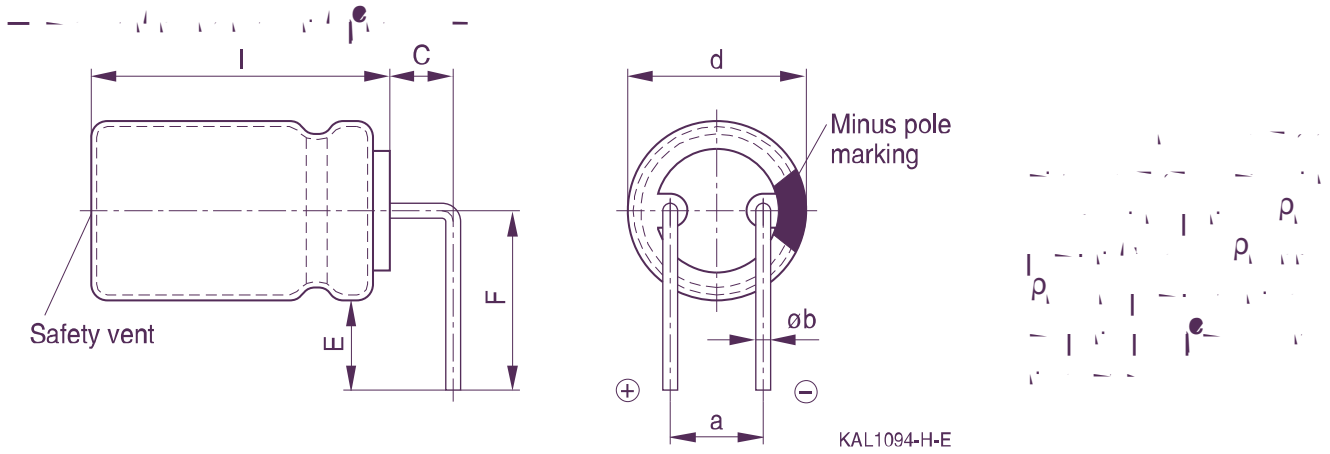

Part Number	Length l	Lead Length C	Body Height H	Lead Height E	Diameter ϕ
×	±	±	±	±	±
×	±	±	±	±	±
×	±	±	±	±	±
×	±	±	±	±	±
×	±	±	±	±	±
×	±	±	±	±	±
×	±	±	±	±	±
×	±	±	±	±	±
×	±	±	±	±	±
×	±	±	±	±	±

For more information, please refer to the datasheet.

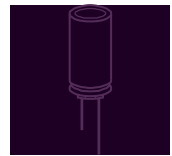

Packing units and box dimensions

Ammo pack

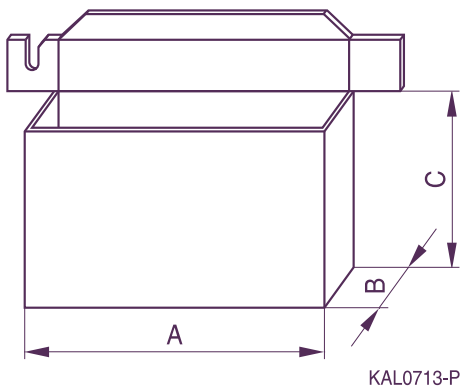

Part No.	Quantity	Weight (g)	Volume (cm ³)	Notes
1	100	0.15	0.15	
2	100	0.15	0.15	
3	100	0.15	0.15	
4	100	0.15	0.15	
5	100	0.15	0.15	
6	100	0.15	0.15	
7	100	0.15	0.15	
8	100	0.15	0.15	
9	100	0.15	0.15	
10	100	0.15	0.15	
11	100	0.15	0.15	
12	100	0.15	0.15	
13	100	0.15	0.15	
14	100	0.15	0.15	
15	100	0.15	0.15	
16	100	0.15	0.15	
17	100	0.15	0.15	
18	100	0.15	0.15	
19	100	0.15	0.15	
20	100	0.15	0.15	

[The main body of the page is mostly blank, suggesting the text is either extremely faint or has been obscured.]

1

B43888

Long useful life – 105 °C



Cautions and warnings

Personal safety













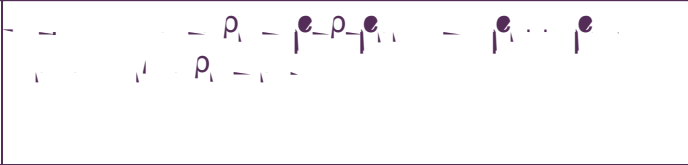

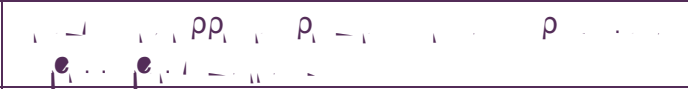







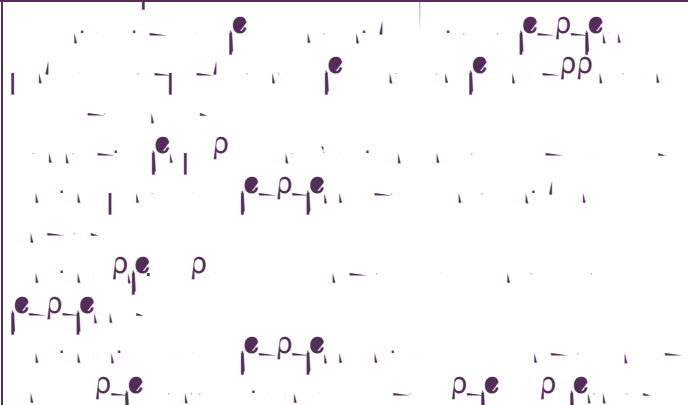
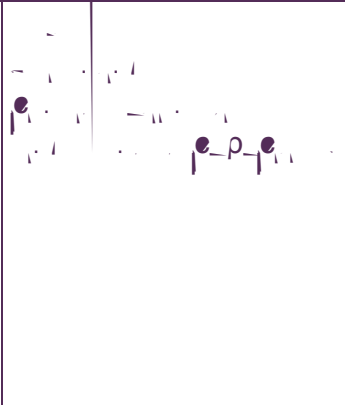



B43888

Long useful life – 105 °C

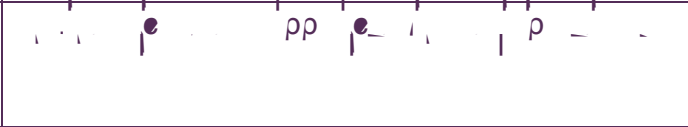
Product safety









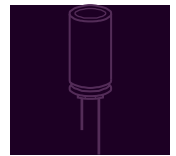





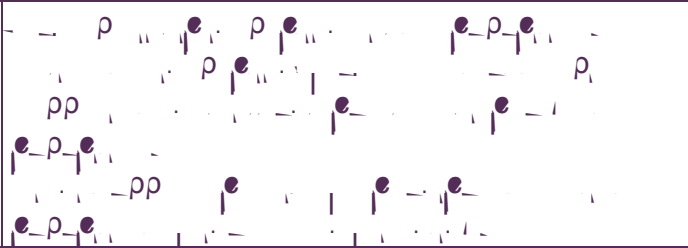

1. The microphone is not to be used in applications where it is exposed to high temperatures, high humidity, or other environmental conditions that may affect its performance or reliability.

Microphone	Microphone	Microphone
		
		
		
		
		
		
		
		
		

B43888

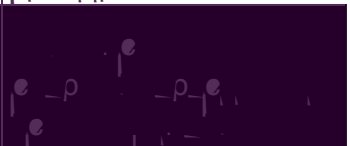
Long useful life – 105 °C



Display of ordering codes for TDK Electronics products

		
---	--	---



B43888

Long useful life – 105 °C

Symbols and terms

<p>①</p> <p>②</p> <p>③</p> <p>④</p> <p>⑤</p> <p>⑥</p> <p>⑦</p> <p>⑧</p> <p>⑨</p> <p>⑩</p> <p>⑪</p> <p>⑫</p> <p>⑬</p> <p>⑭</p> <p>⑮</p> <p>⑯</p> <p>⑰</p> <p>⑱</p> <p>⑲</p> <p>⑳</p> <p>㉑</p> <p>㉒</p> <p>㉓</p> <p>㉔</p> <p>㉕</p> <p>㉖</p> <p>㉗</p> <p>㉘</p> <p>㉙</p> <p>㉚</p> <p>㉛</p> <p>㉜</p> <p>㉝</p> <p>㉞</p> <p>㉟</p> <p>㊱</p> <p>㊲</p> <p>㊳</p> <p>㊴</p> <p>㊵</p> <p>㊶</p> <p>㊷</p> <p>㊸</p> <p>㊹</p> <p>㊺</p> <p>㊻</p> <p>㊼</p> <p>㊽</p> <p>㊾</p> <p>㊿</p>	<p>①</p> <p>②</p> <p>③</p> <p>④</p> <p>⑤</p> <p>⑥</p> <p>⑦</p> <p>⑧</p> <p>⑨</p> <p>⑩</p> <p>⑪</p> <p>⑫</p> <p>⑬</p> <p>⑭</p> <p>⑮</p> <p>⑯</p> <p>⑰</p> <p>⑱</p> <p>⑲</p> <p>⑳</p> <p>㉑</p> <p>㉒</p> <p>㉓</p> <p>㉔</p> <p>㉕</p> <p>㉖</p> <p>㉗</p> <p>㉘</p> <p>㉙</p> <p>㉚</p> <p>㉛</p> <p>㉜</p> <p>㉝</p> <p>㉞</p> <p>㉟</p> <p>㊱</p> <p>㊲</p> <p>㊳</p> <p>㊴</p> <p>㊵</p> <p>㊶</p> <p>㊷</p> <p>㊸</p> <p>㊹</p> <p>㊺</p> <p>㊻</p> <p>㊼</p> <p>㊽</p> <p>㊾</p> <p>㊿</p>	<p>①</p> <p>②</p> <p>③</p> <p>④</p> <p>⑤</p> <p>⑥</p> <p>⑦</p> <p>⑧</p> <p>⑨</p> <p>⑩</p> <p>⑪</p> <p>⑫</p> <p>⑬</p> <p>⑭</p> <p>⑮</p> <p>⑯</p> <p>⑰</p> <p>⑱</p> <p>⑲</p> <p>⑳</p> <p>㉑</p> <p>㉒</p> <p>㉓</p> <p>㉔</p> <p>㉕</p> <p>㉖</p> <p>㉗</p> <p>㉘</p> <p>㉙</p> <p>㉚</p> <p>㉛</p> <p>㉜</p> <p>㉝</p> <p>㉞</p> <p>㉟</p> <p>㊱</p> <p>㊲</p> <p>㊳</p> <p>㊴</p> <p>㊵</p> <p>㊶</p> <p>㊷</p> <p>㊸</p> <p>㊹</p> <p>㊺</p> <p>㊻</p> <p>㊼</p> <p>㊽</p> <p>㊾</p> <p>㊿</p>
<p>①</p> <p>②</p> <p>③</p> <p>④</p> <p>⑤</p> <p>⑥</p> <p>⑦</p> <p>⑧</p> <p>⑨</p> <p>⑩</p> <p>⑪</p> <p>⑫</p> <p>⑬</p> <p>⑭</p> <p>⑮</p> <p>⑯</p> <p>⑰</p> <p>⑱</p> <p>⑲</p> <p>⑳</p> <p>㉑</p> <p>㉒</p> <p>㉓</p> <p>㉔</p> <p>㉕</p> <p>㉖</p> <p>㉗</p> <p>㉘</p> <p>㉙</p> <p>㉚</p> <p>㉛</p> <p>㉜</p> <p>㉝</p> <p>㉞</p> <p>㉟</p> <p>㊱</p> <p>㊲</p> <p>㊳</p> <p>㊴</p> <p>㊵</p> <p>㊶</p> <p>㊷</p> <p>㊸</p> <p>㊹</p> <p>㊺</p> <p>㊻</p> <p>㊼</p> <p>㊽</p> <p>㊾</p> <p>㊿</p>	<p>①</p> <p>②</p> <p>③</p> <p>④</p> <p>⑤</p> <p>⑥</p> <p>⑦</p> <p>⑧</p> <p>⑨</p> <p>⑩</p> <p>⑪</p> <p>⑫</p> <p>⑬</p> <p>⑭</p> <p>⑮</p> <p>⑯</p> <p>⑰</p> <p>⑱</p> <p>⑲</p> <p>⑳</p> <p>㉑</p> <p>㉒</p> <p>㉓</p> <p>㉔</p> <p>㉕</p> <p>㉖</p> <p>㉗</p> <p>㉘</p> <p>㉙</p> <p>㉚</p> <p>㉛</p> <p>㉜</p> <p>㉝</p> <p>㉞</p> <p>㉟</p> <p>㊱</p> <p>㊲</p> <p>㊳</p> <p>㊴</p> <p>㊵</p> <p>㊶</p> <p>㊷</p> <p>㊸</p> <p>㊹</p> <p>㊺</p> <p>㊻</p> <p>㊼</p> <p>㊽</p> <p>㊾</p> <p>㊿</p>	<p>①</p> <p>②</p> <p>③</p> <p>④</p> <p>⑤</p> <p>⑥</p> <p>⑦</p> <p>⑧</p> <p>⑨</p> <p>⑩</p> <p>⑪</p> <p>⑫</p> <p>⑬</p> <p>⑭</p> <p>⑮</p> <p>⑯</p> <p>⑰</p> <p>⑱</p> <p>⑲</p> <p>⑳</p> <p>㉑</p> <p>㉒</p> <p>㉓</p> <p>㉔</p> <p>㉕</p> <p>㉖</p> <p>㉗</p> <p>㉘</p> <p>㉙</p> <p>㉚</p> <p>㉛</p> <p>㉜</p> <p>㉝</p> <p>㉞</p> <p>㉟</p> <p>㊱</p> <p>㊲</p> <p>㊳</p> <p>㊴</p> <p>㊵</p> <p>㊶</p> <p>㊷</p> <p>㊸</p> <p>㊹</p> <p>㊺</p> <p>㊻</p> <p>㊼</p> <p>㊽</p> <p>㊾</p> <p>㊿</p>
<p>①</p> <p>②</p> <p>③</p> <p>④</p> <p>⑤</p> <p>⑥</p> <p>⑦</p> <p>⑧</p> <p>⑨</p> <p>⑩</p> <p>⑪</p> <p>⑫</p> <p>⑬</p> <p>⑭</p> <p>⑮</p> <p>⑯</p> <p>⑰</p> <p>⑱</p> <p>⑲</p> <p>⑳</p> <p>㉑</p> <p>㉒</p> <p>㉓</p> <p>㉔</p> <p>㉕</p> <p>㉖</p> <p>㉗</p> <p>㉘</p> <p>㉙</p> <p>㉚</p> <p>㉛</p> <p>㉜</p> <p>㉝</p> <p>㉞</p> <p>㉟</p> <p>㊱</p> <p>㊲</p> <p>㊳</p> <p>㊴</p> <p>㊵</p> <p>㊶</p> <p>㊷</p> <p>㊸</p> <p>㊹</p> <p>㊺</p> <p>㊻</p> <p>㊼</p> <p>㊽</p> <p>㊾</p> <p>㊿</p>	<p>①</p> <p>②</p> <p>③</p> <p>④</p> <p>⑤</p> <p>⑥</p> <p>⑦</p> <p>⑧</p> <p>⑨</p> <p>⑩</p> <p>⑪</p> <p>⑫</p> <p>⑬</p> <p>⑭</p> <p>⑮</p> <p>⑯</p> <p>⑰</p> <p>⑱</p> <p>⑲</p> <p>⑳</p> <p>㉑</p> <p>㉒</p> <p>㉓</p> <p>㉔</p> <p>㉕</p> <p>㉖</p> <p>㉗</p> <p>㉘</p> <p>㉙</p> <p>㉚</p> <p>㉛</p> <p>㉜</p> <p>㉝</p> <p>㉞</p> <p>㉟</p> <p>㊱</p> <p>㊲</p> <p>㊳</p> <p>㊴</p> <p>㊵</p> <p>㊶</p> <p>㊷</p> <p>㊸</p> <p>㊹</p> <p>㊺</p> <p>㊻</p> <p>㊼</p> <p>㊽</p> <p>㊾</p> <p>㊿</p>	<p>①</p> <p>②</p> <p>③</p> <p>④</p> <p>⑤</p> <p>⑥</p> <p>⑦</p> <p>⑧</p> <p>⑨</p> <p>⑩</p> <p>⑪</p> <p>⑫</p> <p>⑬</p> <p>⑭</p> <p>⑮</p> <p>⑯</p> <p>⑰</p> <p>⑱</p> <p>⑲</p> <p>⑳</p> <p>㉑</p> <p>㉒</p> <p>㉓</p> <p>㉔</p> <p>㉕</p> <p>㉖</p> <p>㉗</p> <p>㉘</p> <p>㉙</p> <p>㉚</p> <p>㉛</p> <p>㉜</p> <p>㉝</p> <p>㉞</p> <p>㉟</p> <p>㊱</p> <p>㊲</p> <p>㊳</p> <p>㊴</p> <p>㊵</p> <p>㊶</p> <p>㊷</p> <p>㊸</p> <p>㊹</p> <p>㊺</p> <p>㊻</p> <p>㊼</p> <p>㊽</p> <p>㊾</p> <p>㊿</p>

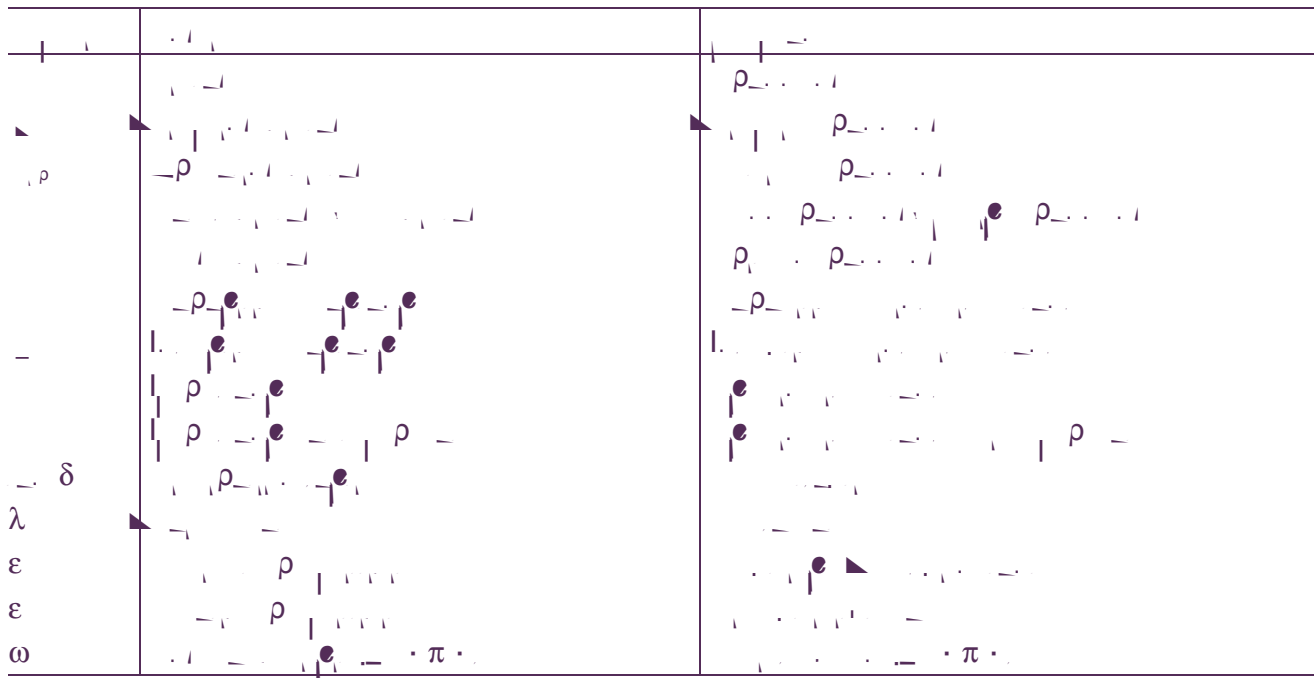
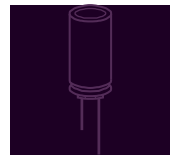

Note

① The parasitic elements are distributed across the component.

Important notes

statements about the suitability of our products for certain areas of application.

that such statements cannot be regarded as binding statements about the suitability of our products for a particular customer application.

in individual cases, a malfunction of electronic components or failure before the end of their usual service life cannot be completely ruled out in the current state of the art, even if they are operated as specified.

The warnings, cautions and product-specific notes must be observed.

some of the products described in this publication may contain substances subject to restrictions in certain jurisdictions (e.g. because they are classed as hazardous).

the products described in this publication may change from time to time.

reserve the right to discontinue production and delivery of products.

all orders are subject to our General Terms and Conditions of Supply.

Important notes

Our manufacturing sites serving the automotive business apply the IATF 16949 standard.

only requirements mutually agreed upon can and will be implemented in our Quality Management System.

